

Reasoning Solution (Memory Based Papers)

Q (1-5):

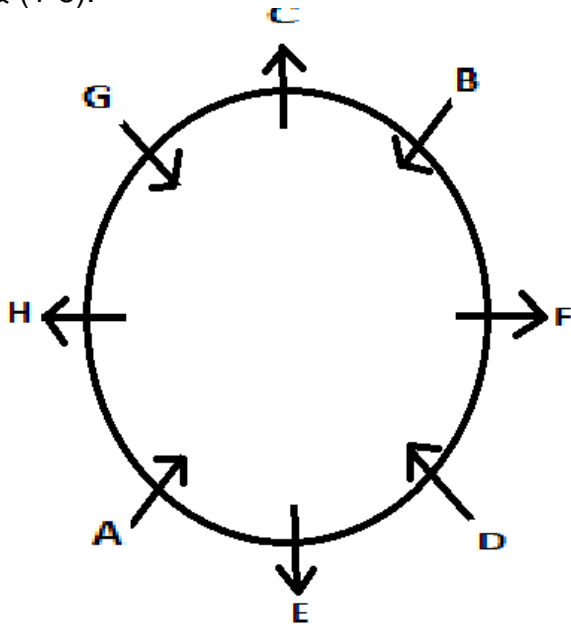

Q6:

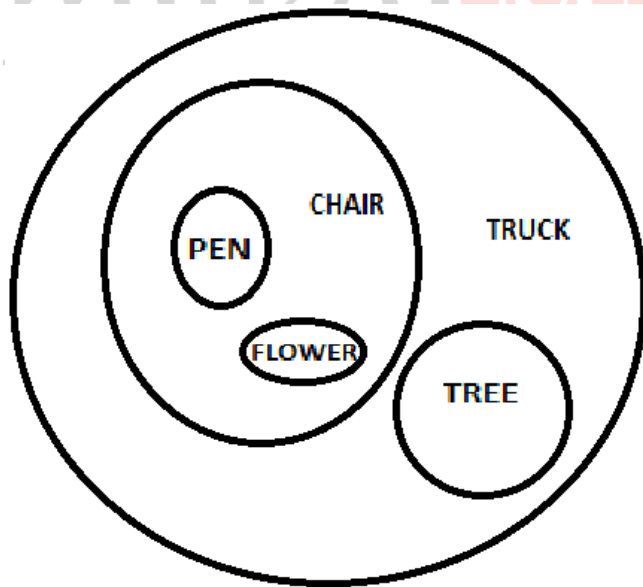

Q7:

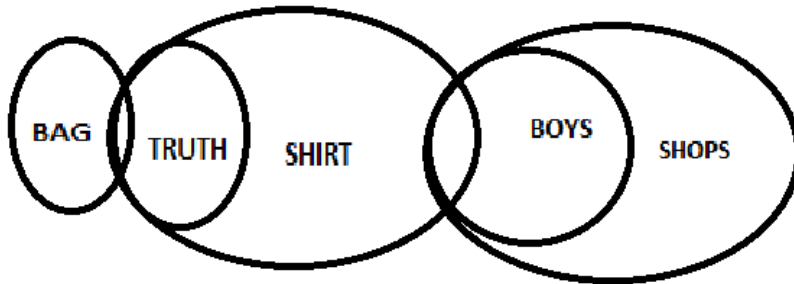

Q8:

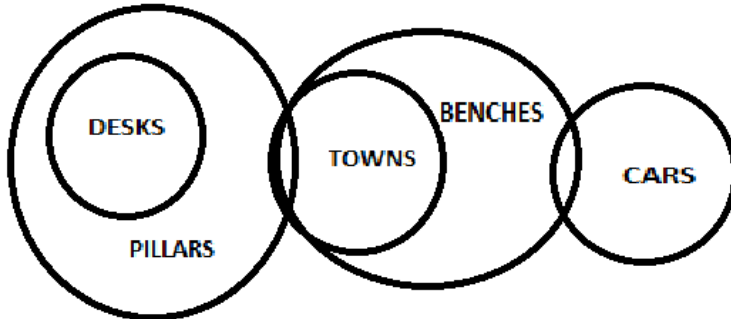

Q9:

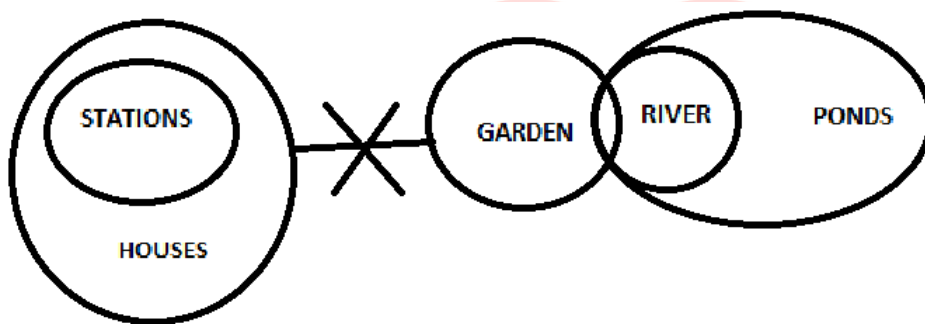

Q10:

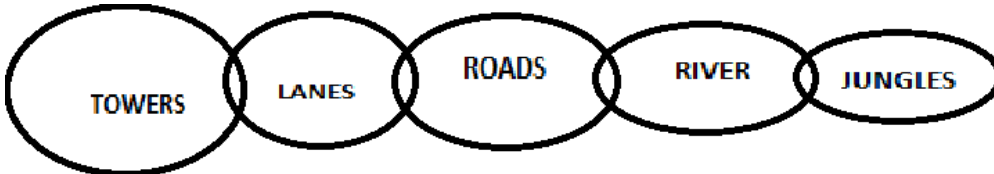

Q11: From Statement I & II, Economy = Ka
demand and Sound = either mo or ta. So and = pa

Q12: Sound = Either mo or ta

Q13: From Statement I & III, money = la

Q14: From Statement III & IV, more = zi

Q15: Economy = ka

Q16: E > P (True)

R < L (True)

Q17: S > E (TRUE)

L < S (TRUE)

Q18: P > N (FALSE)

G ≥ Y (FALSE)

Q19: K>N (FALSE)
 I<Z (FALSE)
 Q20: J>O (FALSE)
 G<Y (FALSE)

Q (21-25):

DAYS	PERSON	COLOUR
SUN	F	BLACK
MON	A	RED
TUE	G	WHITE
WED	C	YELLOW
THU	B	PINK
FRI	D	GREEN
SAT	E	BLUE

Q (26-30):

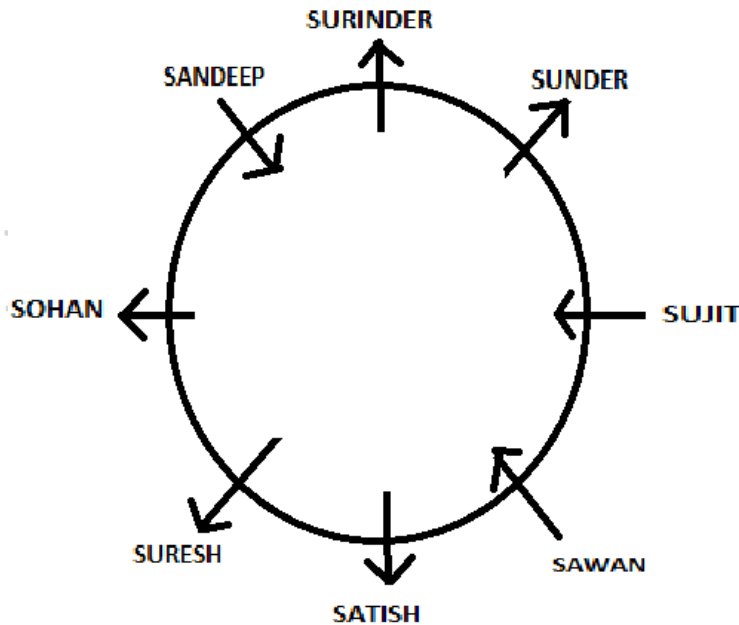

PERSON	BOOK
SURESH	STORY
SURINDER	STORY
SAWAN	BIOGRAPHY
SATISH	BIOGRAPHY
SUNDER	POETRY
SOHAN	ECONOMICS
SANDEEP	POETRY
SUJIT	ECONOMICS

Q31:

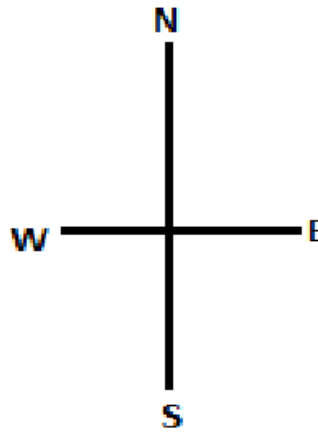
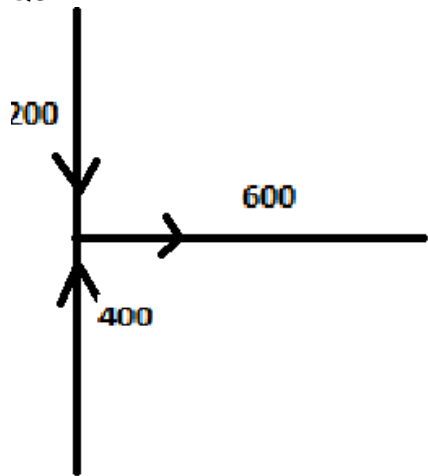

Q32:

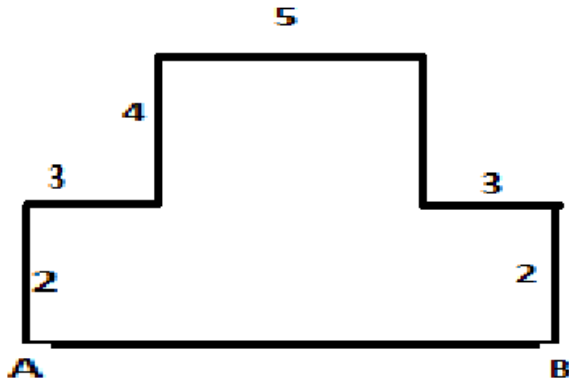

Q33:

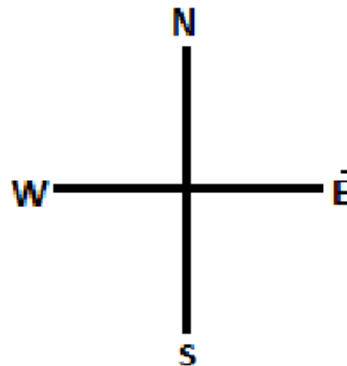
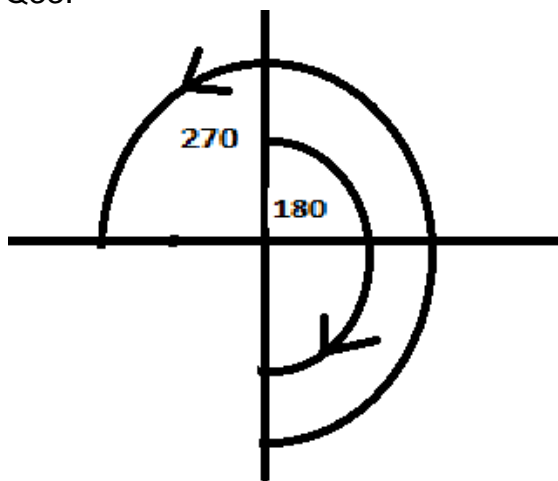

Q34: Since J is brother of I and I is father of E. So J is uncle of E

Q35: G is father of I and I is father of B. So G is grandfather of B.